

RoHS Compliant Customer Drawing

REV.	ECN NO.	DESCRIPTION	DATE	DESIGN

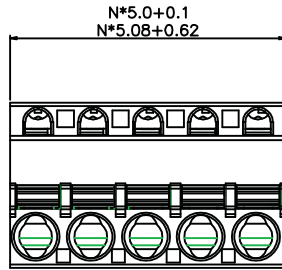
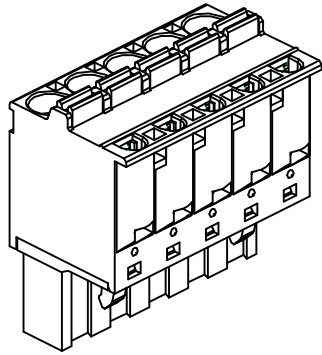

**SPECIFICATION**

**MATERIAL**

Housing:PA66,UL94V-0  
Terminal:Phosphor Bronze,Tin Plated  
Wire Guard:Stainless Steel

**ELECTRICAL**

Rated voltage:300V  
Rated current: 15A  
Wire Range(AWG/MM<sup>2</sup>):24-12AWG/0.2-2.5MM<sup>2</sup>  
Withstanding voltage: AC2500V/ 1Min

**MECHANICAL**

Strip Length:10mm  
Operating Temperature: -40°C~+105°C

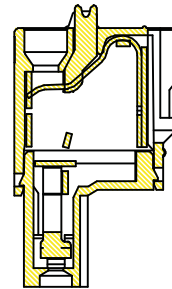
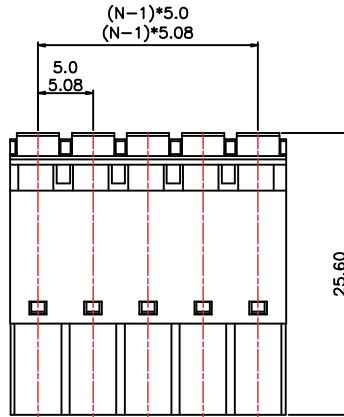
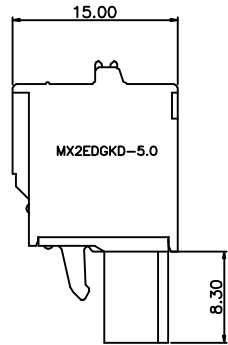

**订购方式/HOW TO ORDER**

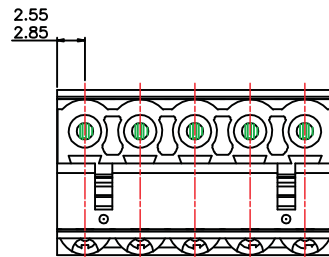
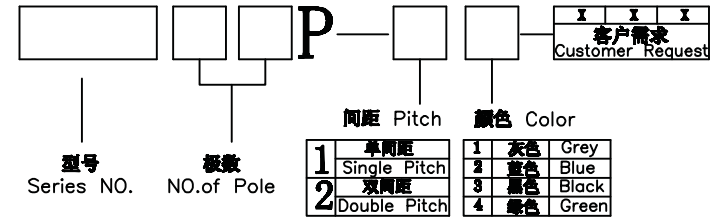

N=No. of contacts

**Contact Us**

TEL:+86-574-63510149

FAX:+86-574-63516735

E-Mail:Sales@cxsuteng.com

Website:www.cxsuteng.com

公差一览表 TOLERANCE UNLESS OTHERWISE				慈溪市速腾电子有限公司 CIXI SUTENG ELECTRONIC CO., LTD					
X.	±0.25	X°	±5°	单位 UNITS	mm	制图 DRAWING	No.01	产品名称 TITLE	ST2EDGKD-5.0/5.08
.X	±0.20	.X°	±2°	角法 VIEW	第三角	设计 DESIGN	No.06	产品料号 PART NO.	ST2EDGKD-5.0/5.08
.XX	±0.15	.XX°	±1°	比例 SCALE	1:1	审核 CHKD		图号 DRAW NO.	ST2EDGKD-5.0/5.08
.XXX	±0.02	.XXX°	±0.5°	日期 DATE	2012.07.10	版本 APPD	AO		